

2382A FLAT-FRONT BI-RADIAL HORN



FEATURES:

- Uniform horizontal on- and off-axis frequency response
- Precise horizontal and vertical pattern control
- Full horn loading to 500 Hz
- Flat front and compact size
- Lightweight construction
- 49 mm (2 in) throat entry

The JBL 2382A Bi-Radial™ horn¹ is designed for flush cabinet mounting or compact cluster applications. The 2382A has a nominal 120° horizontal x 40° vertical pattern. The horn provides uniform on- and off-axis frequency response from 500 Hz to beyond 16 kHz in the horizontal plane and 2 kHz to 16 kHz in the vertical plane, with uniform directivity above 2 kHz. The horn's vertical mouth dimension (just slightly larger than the compression driver used to drive the horn) allows very compact single and multiple horn/driver systems to be put together. Should tighter vertical pattern control be required below 2 kHz, two or more horns may be stacked vertically in line.

The exceptionally consistent horizontal dispersion eliminates the midrange narrowing and high frequency beaming problems typically associated with

JBL

2382A

conventional horn designs. Additionally, the predictable performance of the 2382A greatly simplifies cluster design. The need for horn overlapping is minimized, and lobing and comb filter effects are virtually eliminated.

Computer-aided design techniques were used to derive the horn contours in both horizontal and vertical planes. Using sidewall contours based on a polynomial power series equation, the horn design yields smooth response, low distortion, and consistent coverage over defined solid angles. The design avoids

the performance disadvantages of horns that feature sharp flare transitions and flat sidewalls. To ensure light weight, superior strength, and freedom from resonances, the horn is made of molded structural foam.

The 2382A will accept the 49 mm (2 in) throat 2441, 2445, or 2485 compression driver. With the addition of the 2327 adapter, the horn will also accept the 25 mm (1 in) throat 2425 driver.

U.S. Patent No. 4,308,932. Foreign patents pending.

SPECIFICATIONS:

Horizontal Coverage:		Construction:	Molded structural foam (nominal 10 mm (0.38 in.) wall thickness)
Angle Degrees (-6 dB):	120 (+10, -20)	Overall Dimensions:	
Average Range:	500 Hz — 16 kHz	Mouth Height:	279 mm (11 in)
Vertical Coverage:		Mouth Width:	445 mm (17.5 in)
Angle Degrees (-6 dB):	40 (+26, -11)	Length:	236 mm (9.28 in)
Average Range:	2 kHz — 16 kHz	Mounting Dimensions:	
Directivity Index (DI):	9 (+3, -2 dB)	Rear Height:	235 mm (9.25 in)
Directivity Factor (Q):	7.9 (+7.9, -2.9)	Rear Width:	400 mm (15.75 in)
Average Range:	500 Hz — 16 kHz	Baffle Cutout Required:	(Front mounting only)
Usable Low-Frequency Limit:	400 Hz	Height:	238 mm (9 ⁷ / ₈ in)
Recommended Crossover Frequency:	500 Hz	Width:	403 mm (15 ⁷ / ₈ in)
Axial Pressure Sensitivity:	110 dB SPL, 1 W, 1 m	Net Weight:	1.62 kg (3.5 lb)
		Shipping Weight:	3.42 kg (7.5 lb)

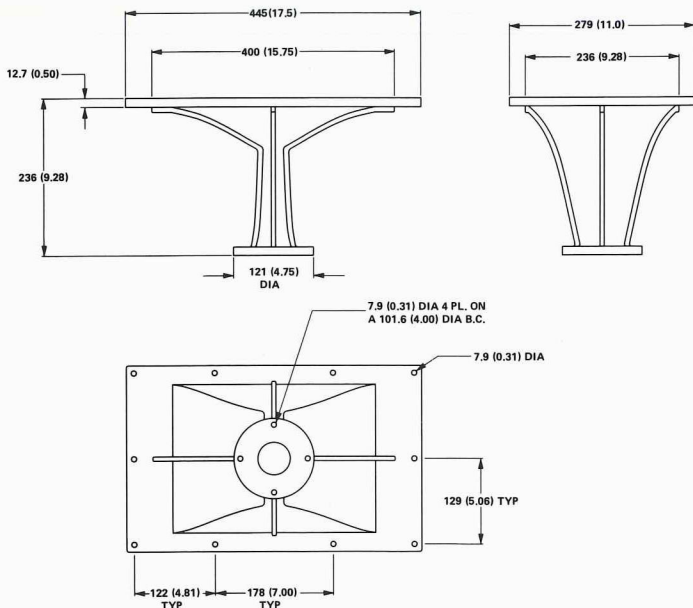

Beamwidth vs Frequency

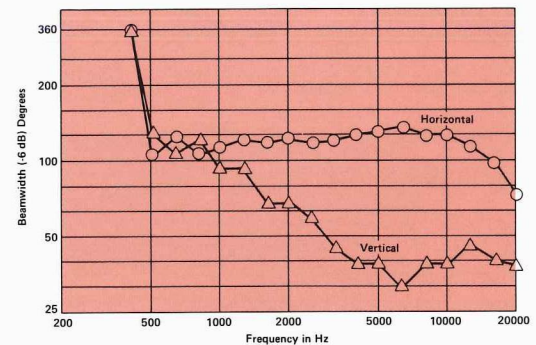

Directivity vs Frequency

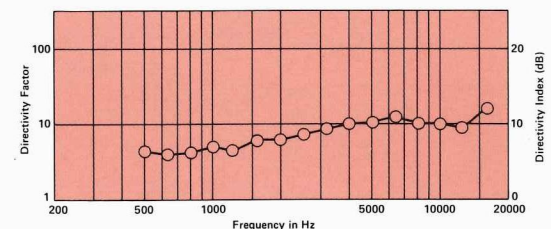

Frontal Isobar Contours

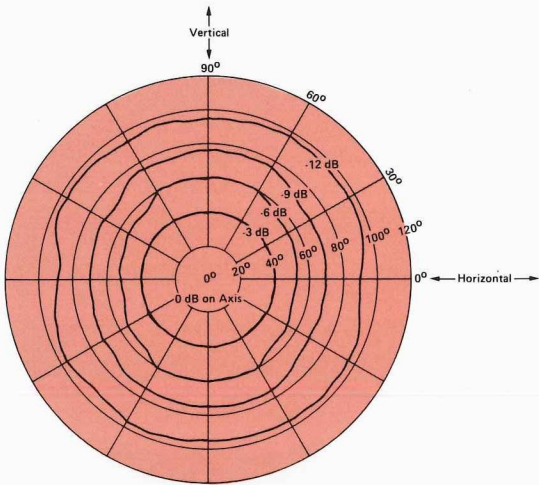

500 Hz octave bandwidth constant sound pressure contours of 0 to -12 dB in steps of 3 dB. The contours are plotted on polar grid lines with on axis being center of the plot. The data was gathered by taking octave polar plots at oblique angles from 0° (horizontal) to 90° (vertical) in steps of 10°.

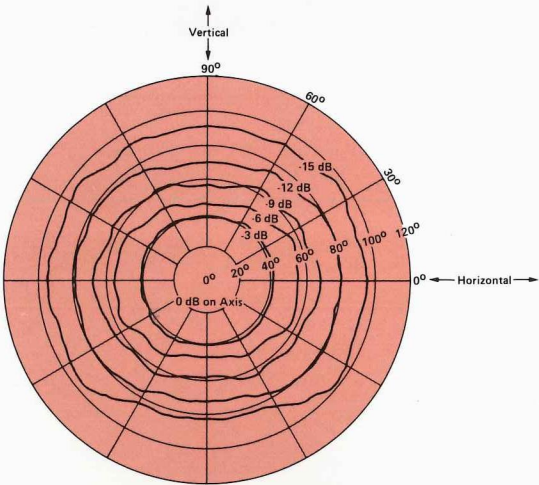

1 kHz octave bandwidth constant sound pressure contours from 0 dB to -15 dB.

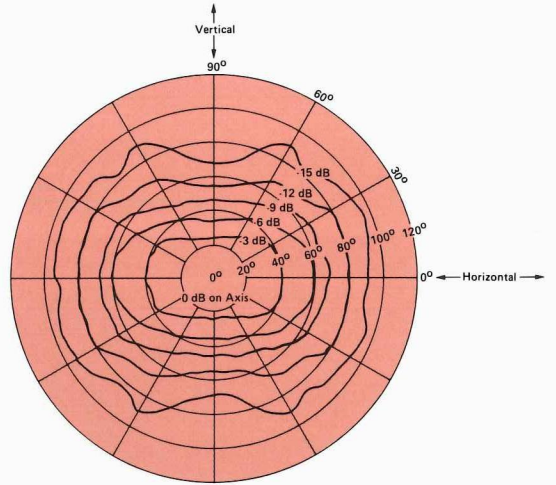

2 kHz octave bandwidth constant sound pressure contours. Same conditions as 1 kHz contours.

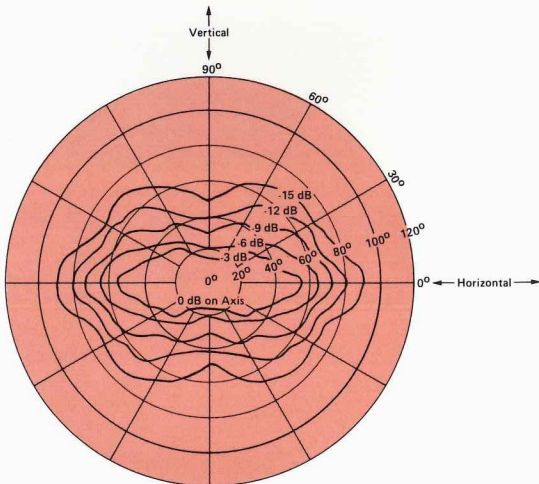

4 kHz octave bandwidth constant sound pressure contours. Same conditions as 1 kHz contours.

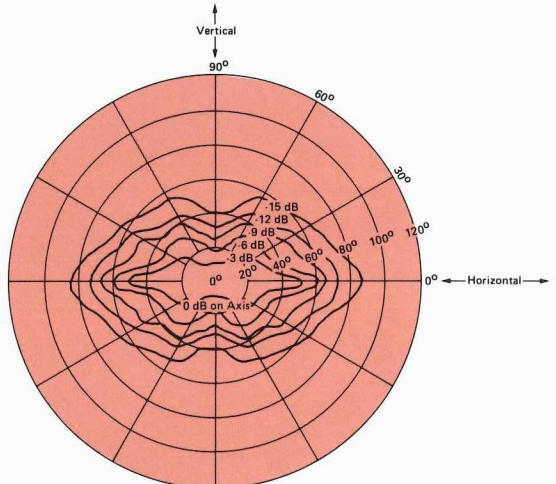

8 kHz octave bandwidth constant sound pressure contours. Same as 1 kHz contours.

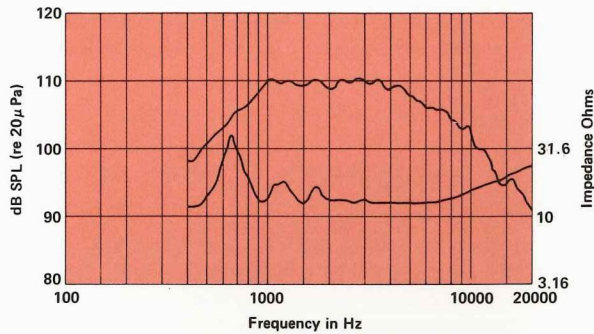

Frequency response and impedance.

Frequency response of the 2382A, measured on axis at a distance of 1 meter with 1 watt (4 V RMS) applied to a JBL Model 2445 compression driver, in a reflection-free environment, with impedance vs frequency curve.

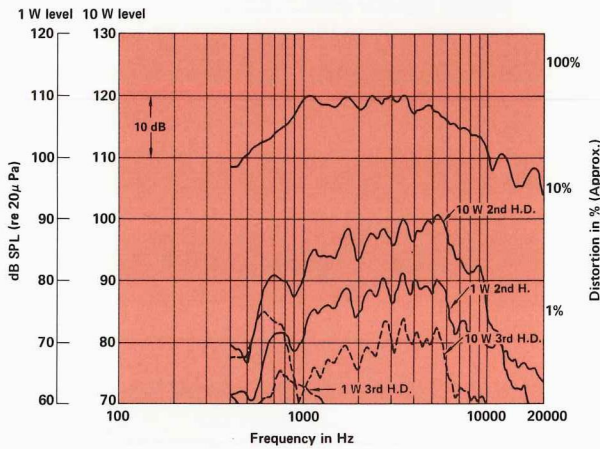

Harmonic distortion. Second and third harmonic distortion curves of the 2382A with 1 watt (4.0 V RMS) and 10 watts (12.65 V RMS) applied to the JBL Model 2445 compression driver. Measured on axis at a distance of 1 meter in a reflection-free environment.

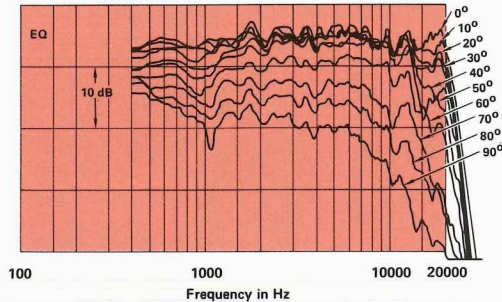
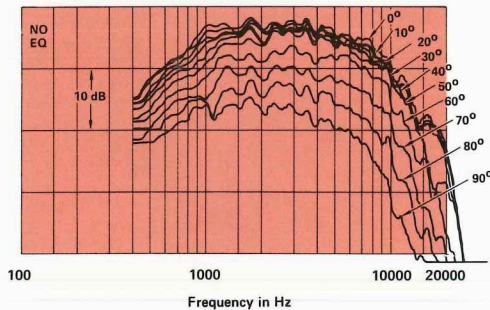

Horizontal off-axis response. Horizontal off-axis response taken at 15° intervals out to 90° off axis. Both normalized (equalized flat on axis) and unequalized responses are shown.

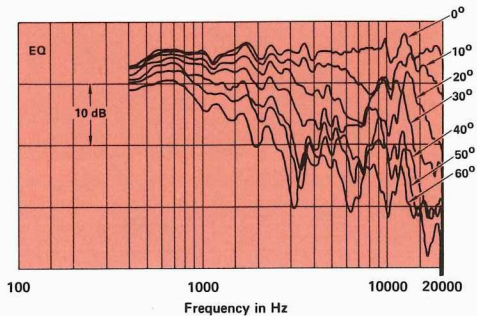
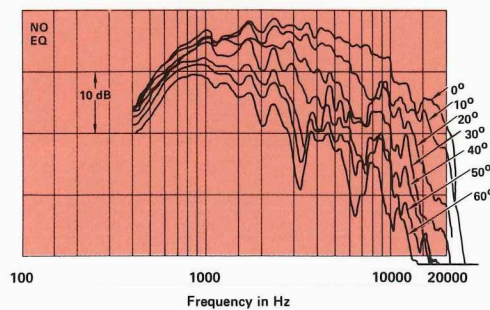

Vertical off-axis response. Vertical off-axis response taken at 15° intervals out to 60° off axis. Both normalized (equalized flat on axis) and unequalized responses are shown.

